

FACTS *engineering*

AutomationDirect.com™

Direct Logic 105

105 DeviceNet Slave

F1-DVNET



Manual Order Number: F1-DVNET-M

TRADEMARKS

TM **Automationdirect.com** is a Trademark of **Automationdirect.com** incorporated.

COPYRIGHT

Copyright 2000, FACTS Engineering LLC., 8049 Photonics Dr., New Port Richey, Florida, 34655.. World rights reserved. No part of this publication may be stored in a retrieval system, transmitted, or reproduced in any way, including but not limited to photocopy photograph, magnetic or other recording media, without the prior agreement and written permission of FACTS Engineering, LLC

Last Issued Date: December 2000
Current Issued Date: December 2000

WARNING

Thank you for purchasing automation equipment from FACTS Engineering. We want your new FACTS Engineering automation equipment to operate safely. Anyone who installs or uses this equipment should read this publication (and any other relevant publications) before installing or operating the equipment.

To minimize the risk of potential safety problems, you should follow all applicable local and national codes that regulate the installation and operation of your equipment. These codes vary from area to area and usually change with time. It is your responsibility to determine which codes should be followed, and to verify that the equipment, installation, and operation is in compliance with the latest revision of these codes.

At a minimum, you should follow all applicable sections of the National Fire Code, National Electrical Code, and the codes of the National Electrical Manufacturers Association (NEMA). There may be local regulatory or government offices that can help determine which codes and standards are necessary for safe installation and operation.

Equipment damage or serious injury to personnel can result from the failure to follow all applicable codes and standards. We do not guarantee the products described in this publication are suitable for your particular application, nor do we assume any responsibility for your product design, installation, or operation.

If you have any questions concerning the installation or operation of this equipment, or if you need additional information, please call us at 1-800-783-3225.

This document is based on information available at the time of its publication. While efforts have been made to be accurate, the information contained herein does not purport to cover all details or variations in hardware and software, nor to provide for every possible contingency in connection with installation, operation, and maintenance. Features may be described herein which are not present in all hardware and software systems. FACTS Engineering assumes no obligation of notice to holders of this document with respect to changes subsequently made. FACTS Engineering retains the right to make changes to hardware and software at any time, without notice. FACTS Engineering makes no representation or warranty, expressed, implied, or statutory with respect to, and assumes no responsibility for the accuracy, completeness, sufficiency, or usefulness of the information contained herein. No warranties of merchantability of fitness for purpose shall apply.

CONFORMANCE

This device has been conformance tested and found to comply with ODVA Protocol Conformance Test Software.



The following products carry the Certification Mark:

F1-DVNET-AR

F1-DVNET-DR

F1-DVNET-DD

TABLE OF CONTENTS

CHAPTER 1: INTRODUCTION	2
Quick Stats	2
F1-DVNET Description	3
Platform Description	3
EMI and the 5-pin Connector	3
Requirements	3
Specifications.....	4
LED Indicators	4
Network Wiring	4
J1 Jumper and the Clear-All Function	5
Configuration	5
Applications	5
CHAPTER 2: DeviceNet PROTOCOL	6
DeviceNet I/O Poll Command/Response Message.....	6
DeviceNet Explicit Request/Response Message	6
DeviceNet commands	6
Class 1 Identity	6
Class 3 DeviceNet Object	6
Class 4 Assembly.....	6
Class 5 Connection	7
Class 15 Parameters.....	8
Parameters	8
Modes and I/O	10
How to Control the F1-DVNET Module	10
How to Establish Connections	10
How to Change the Baud Rate	10
How To Change A Macid.....	10
How to Set the EPR.....	11
How To Send Parameters	11
How to Establish a Polling Connection	11
Glossary.....	12
APPENDIX A: EDS File	14
APPENDIX B: PC Loader Program	16
F1-DVNET Loader.....	16
Loader Basics	16
Download Programs	17
Examine memory.....	17

CHAPTER 1: INTRODUCTION

This document describes the operation of the F1-DVNET module. The hardware is very similar to the F1-130 module. The footprint and I/O are identical and even the cases are alike, but the operation is completely different. Since F1-DVNET is a DeviceNet network device, it must receive commands from a master device on the network.

F1-DVNET is a Group2 only server that does not support UCMM (Unconnected Message Manager). It uses the Predefined Master/Slave Connection Set and can communicate ONLY with the identifiers defined within that group. Refer to chapter 7 volume I of the ODVA (Open DeviceNet Vendor Association) DeviceNet Specification

F1-DVNET is the generic name of the module. A suffix is used to completely identify the module and the type of I/O in use. As of this writing there are three types of F1-DVNET:

F1-DVNET-DR DC Inputs 12-24 VDC Sinking/Sourcing; Relay Outputs 12-30 VDC
F1-DVNET-DD DC Inputs 12-24 VDC Sinking/Sourcing; DC Outputs 5-30 VDC
F1-DVNET-AR AC Inputs 80-132 VAC; Relay Outputs 12-30 VDC

Visit our web site at www.facts-eng.com for the current support files (EDS file, BMP, PDF files) for the F1-DVNET.

Quick Stats

F1-DVNET initially has a network address (MACID) of 63(3FH) and a baud rate of 125K.

F1-DVNET supports polling and explicit messaging. It has four optional operating modes that run “under the hood” to provide enhanced I/O control. Refer to F1-DVNETAN, an application notes manual, for a more complete description or contact FACTS Engineering.

This is a FLASH memory system and field upgrades are possible. The unit has an associated loader and utility that is explained in appendix B.

F1-DVNET Description

The information presented in this manual is based on the Open DeviceNet Vendor Association (ODVA) specifications Volume I version 2.0 and Volume II version 2.0. DeviceNet is a trademark of Open DeviceNet Vendor Association, Inc.

F1-DVNET is the product name of the AutomationDirect 105 PLC designed to operate using the DeviceNet protocol. This industrial protocol incorporates CAN (Controller Area Network) technology that links up to 64 nodes on a single network.

Platform Description

The CPU is a Dallas 87C520, a member of the 8051 family of fast micro controllers. It has a 16 MHz clock, 2k ROM Boot loader and up to 62K of FLASH-based application code. It has an RS-232 interface for memory upgrades and a 5-pin pioneer style interface for DeviceNet connections. Figure 3.1 shows the F1-DVNET communication Port pin out configuration.

Figure 3.1 Port Pinout

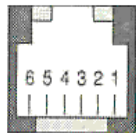

Phone Jack
Connector

Port Pinouts	
Pin	Signal Definition
1	0 V
2	5 V
3	RS232C Data in
4	RS232C Data out
5	5 V
6	0 V

EMI and the 5-pin Connector

F1-DVNET has a non-conductive enclosure and will not have drain connection coupling. The center pin of the 5-pin DeviceNet connector is unconnected. Refer to page 9-8 of the ODVA specification.

Requirements

This device is a server (slave) device designed using the Predefined Master-Slave Connection set as defined in chapter 7 of Volume I of the ODVA spec. It requires commands from a master on the network that provides total application control. This master can be a PC or embedded device.

Specifications

DATA RATE	TRUNK DISTANCES	DROP LENGTH	
		MAXIMUM +++++	CUMULATIVE +++++
125K	500M (1640 FT)	6M (20FT)	156M (512FT)
250K	250M (820FT)	6M (20FT)	78M (256FT)
500K	100M (328FT)	6M (20FT)	39M (128FT)
MACID	0 – 63 Each device has a unique value for a total of 64 devices on the network		
Protocol	Predefined Master-Slave Connection Set		
LED Status Indication	PWR LED – green The power indicator OD LED -- green The operational state of the unit ET LED -- red Failed communication device; Rapid flashing data being sent via the com1 connection.		
DeviceNet Port	5-conductor (signal pair, bus power pair, drain)		
COM1 Port	RJ-12 6P6C (Proper cable/connector in FA-CABKIT)		
Maximum I/O	10 inputs 8 outputs		

LED Indicators

F1-DVNET has a green PWR LED, a green OD LED and a red ET status LED.

PWR LED is solid green when power is applied. If this LED is out the power is off, the unit is bad or the LED is bad.

OD LED illuminates when the CPU and system become operational.

Solid off	Performing internal tests or bus-power missing
Flashing	Flashing at approximately ¼ second on/off intervals, the unit is not under master control. NOTE: It is possible for the Master to establish and break connections using short bursts which would prevent a solid-on LED. The module would communicate effectively, but the LED would appear to indicate no communication. Observe the LED closely. The LED will flash at a constant rate when there are no connections. When traffic occurs even for short periods there is usually a change in the flashing rate.
Solid on	Unit is under master control

ET LED illuminates when the CPU is operational AND an error is detected in the communication device. It also serves as an indicator of traffic (output) on the COM1 port.

Solid off	No error
Flashing	At power-up the F1-DVNET tries to communicate with the device attached to the RS-232 port. It is seeking a program loader and will send a special message to ask the loader, if connected, to proceed with a download. During this power-up period the red LED will flash on/off once. Other problems such as timeouts will cause an extended flashing of the network status LED. Flashing usually indicates a non-fatal error.
Solid on	The unit has a fatal communication device. If the CAN connection experiences error conditions the LED will turn solid on. This is a fatal condition that can only be remedied by cycling main power to the unit. If bus-power is removed when the system is in RUN mode this LED will turn solid on This condition is non-fatal and will be remedied by re-connecting bus power.

Network Wiring

F1-DVNET has the following pin assignments

Pin	Description
+++	+++++++
1	V- Black Ground(bus minus)
2	CAN_L Blue CAN Low
3	Drain Bare
4	CAN_H White CAN High
5	V+ Red (bus positive)

J1 Jumper and the Clear-All Function

This jumper is available to restore the F1-DVNET to an out-of-box condition with regard to network node addressing and baud rate. The J1 jumper is used ONLY to reset the device's communication variables and it can only take effect upon during power up.

Power-up the F1-DVNET with the J1 jumper shorted (pins connected) to set the device's factory default settings of Macid = 63 and the baud rate to 125K. Remove the jumper and the unit will complete its power-up sequence. Another option is to power-down the device, remove the J1 jumper and power-up to resume normal operation. The jumper MUST be removed or the unit will remain in the initialization sequence and will NOT communicate.

If the jumper is applied after initialization (blinking run light) the condition is ignored...no defaults installed. It is not recommended, however, since the next reset WILL flush the Macid and baud rate when the jumpered connection is detected.

NOTE: Caution is the word when changing baud rates on a DeviceNet network. Devices with different baud rates can disrupt the system and foul communications in general, so it is wise to make baud rate changes in isolation from the rest of the network.

Configuration

Only the Macid and Baud rate need to be set for network communication. Once the initial communication from the Master establishes the connection, the baud rate and macid values are permanently stored in FLASH and will be used as settings for subsequent communications. The user can verify the Macid and baud values by connecting an RS-232 application (such as HyperTerminal) to the 232 port of the F1-DVNET unit and cycling power. A special 'I Am Here' message is transmitted out the port in an attempt to seek-out a program loader. This special message has the form:

F1-DVNET MACID=xx CAN Baud Rate=ABCK Va.b T-5D ROM mm/dd/yyyy FLASH mm/dd/yyyy

xx can be 0-63 and ABC is 125, 250 or 500. These values can, of course, be changed once communications has been established.

Va.b refers to the version and revision

T refers to the type of FLASH

ROM date refers to the creation date of the ROM portion of software

FLASH date refers to the creation date of the ROM portion of software

Applications

The master of the network is in charge of F1-DVNET. It must establish itself as being in charge by sending the slave a special command that opens up a dedicated connection between both devices. The user must be aware that only one master can talk to an F1-DVNET device at any one time. Once a master establishes control of the F1-DVNET, only that master will be allowed to send commands to the device. Of course, when the Master releases the connection (de-allocates) then F1-DVNET will be available to any Master that resides on the network.

CHAPTER 2: DeviceNet PROTOCOL

DeviceNet I/O Poll Command/Response Message

The Poll command is transmitted by the master and is directed toward F1-DVNET. It is used for data transfer between the two devices. F1-DVNET accepts the master's data as output data and returns the 10-bits of input data in return.

DeviceNet Explicit Request/Response Message

These commands perform reading/writing of attributes such as serial numbers and application parameters. They are sent and received by a single connection object. More than 8-bytes of data can be sent/received in this method because the system uses fragmented messaging.

DeviceNet commands

Each command is comprised of several fields that together make up a complete message. When commands are generated it is important to remember the numbering base used by the system in use. The value 15, for example is not the same as 15 in hexadecimal notation. Please verify all numerical values selected.

Service	Refers to the activity type associated with this message...Get, Set, etc
Class	Refers to the particular component being addressed. Usually is comprised of One or more objects and all the classes make up the product. There are many Classes and only a small number of them are required
Attribute	Refers to the unique characteristic of an object
Instance	Refers to the specific occurrence of an object. Exists within a specific period of time

Class 1 Identity

Attribute	Instance	Item	Value	Description	Service
1	1	Vendor ID	660d / 294h	Uniquely assigned by ODVA	Get
2	1	Product type	0	General Purpose I/O	Get
3	1	Product code	10	Vendor assigned	Get
4	1	Revision Maj/Min		Released product version	Get
5	1	ID status	1	Entire device status	Get
6	1	Serial Number	XXXXXXXX	32-bit vendor assigned	Get
7	1	Product Name	F1-DVNET	Vendor assigned	Get
0	1	Reset	-----	Reset the device	Reset

Class 3 DeviceNet Object

Attribute	Instance	Item	Value	Description	Service
1	1	Macid	0-63d/0-3Fh	MACID	Get/Set
2	1	Baud Rate	0-2	0=125k, 1=250k, 2=500k	Get/Set
3	1	Bus-off interrupt	X	Bus-off interrupt Process	Get
4	1	Bus-off count	X	Bus-off count	Get/Set
5	1	Allocation	0,1,2,3	Explicit or Poll	Get

Class 4 Assembly

Attribute	Instance	Item	Value	Description	Service
3	1	Produced data	10 bits	Two bytes of input data	Get
3	2	Consumed Data	8 bits	One byte of output data	Get
3	2	Consumed data	8 bits	One byte of output data	Set

Class 5 Connection

Attribute	Instance 1=Explicit 2=Polling	Item	Value	Description	Service
1	1 or 2	Cnxn Attr ID	x	0=none, 1=configuring, 2=waiting, 3=connected, 4=timed-out	Get
2	1 or 2	Cnxn Type	x	0=explicit, 1=I/O	Get
3	1 or 2	Cnxn Trigger ID	x	83H=explicit, 82H=I/O	Get
4	1 or 2	Cnxn Produced ID	x	FFFF=no production	Get
5	1 or 2	Cnxn Consumed ID	x	FFFF=no consumption	Get
6	1 or 2	Cnxn Comm Characteristics	21h/33d	MSG group 2 Consuming MSG group 2 producing	Get
7	1 or 2	Produced Cnxn size	X	2 bytes poll/explicit	Get
8	1 or 2	Consumed Cnxn size	X	1 byte poll/explicit	Get
9	1 or 2	Cnxn EPR	X	Number of milliseconds	Get/Set
12	1 or 2	Cnxn Timeout Action	0	WD time-out action	Get
13	1 or 2	Produced Path Length	X	0/6	Get
14	1 or 2	Produced path attr ID	0/string	0/6 characters	Get
15	1 or 2	Consumed path length	X	0/6	Get
16	1 or 2	Consumed attr ID	0/string	0/6 characters	Get
17	1 or 2	Production Inhib time	X		Get
---	1 or 2	Reset	---	Restart	Reset

Class 15 Parameters

Attribute 1 - 6	Instance	Item	Value	Description	Service
	1	Start Mode	00,00	Start processing mode	Get/Set
	2	Mode_105	60	Selects the mode	Get/Set
	3	HSP allow	XX	Number of presets	Get/Set
	4	Output mask	XX	One mask for all counters	Get/Set
	5	Which preset	Index	8 bits(instance 9)	Get/Set
	6	Output points	Index	Which 8 bits	Get/Set
	7	Mode 30 Profile	2=trap, 4=reg 8=velocity	Mode 30 has 3 modes of operation	Get/Set
	8	Target Velocity	XXXX	16 bits	Get/Set
	9	Preset value	XXXXXXXX	32 bits	Get/Set
	10	Target Position	XXXXXXXX	32 bits	Get/Set
	11	Start Velocity	XX	40 Hz or greater	Get/Set
	12	Accel time	X, Y	Tens.units of seconds	Get/Set
	13	Decel time	X, Y	Tens.units of seconds	Get/Set
	14	Mode operation reset		Clears operation values	Get/Set
	15	Filter time	Index, value	Inputs 1-4 are pulse or filtered. 8mls increments	Get/Set

Parameters

Parameters comprise the largest command section and allow setting of the operating modes so this section deserves a few words.

The class section contains few attributes:

Attribute	Meaning
02	Maximum parameter instance
08	Class descriptor
09	Config assembly instance

Attributes and instances are the important items of this section. Each instance describes a different object and each object is described by a number of attributes. There are 15 different objects (parameters) in this section used to move operational data in and out of the system. Each parameter is comprised of several attributes that include items such as value and size that totally describe the parameter.

Attribute	Meaning
1	Parameter value...this is the bottom line...the value of the item
2	Link path size...no path...this is 0 for all parameters
3	Link path...we have none
4	Description of parameter data...0...no data descriptor
5	Data type 1 for all...8 bits unsigned
6	Number of bytes varies from 1 to 4

Parameter (Instance)	Attribute	Service	Data	Comment
1	1	Get	0	This is the value of the high-speed counter...lsb
	1	Get	1	This is the value of the high-speed counter...msb
	1	Set	0 0	Starts the mode processing...Run
	6	Get	2	Number of bytes
2	1	Get		This is the value of the current operating mode
	1	Set	x	Sets the mode process...10,20,30,60
	6	Get	1	Number of bytes
3	1	Get		The number of presets in the compare process
	1	Set	x	Sets the number of presets in the compare process
	6	Get	1	Number of bytes
4	1	Get		'ALLOW COUNTERS'
	1	Set	x	The number of allowed bits for the compare process
	6	Get	1	Sets allowed bits for the compare process
5	1	Get		Number of bytes
	1	Set	x	The number of the preset counter 1 bytes
	6	Get	2	Sets number of the preset counter 1 bytes
6	1	Get		Number of bytes
	1	Set	x	The allowed output bits
	6	Get	1	Sets the allowed output bits
7	1	Get		Number of bytes
	1	Set	x	The profile used with mode 30
	6	Get	1	Sets the trapezoidal, registration or velocity profile
8	1	Get		Number of bytes in the profile
	1	Set	x	The target velocity in 16 bits
	6	Get	2	Sets the target velocity
	7	Get		Number of bytes
9	1	Get		'TARGET VELOCITY'
	1	Set	x	The preset value
	6	Get	4	Sets preset value
10	1	Get		Number of bytes
	1	Set	x	The target position
	6	Get	4	Sets the target position
11	1	Get		Number of bytes
	1	Set	x	The starting velocity value
	6	Get	2	Sets the starting velocity value...lowest is 40Hz
12	1	Get		Number of bytes
	1	Set	x	The acceleration value
	6	Get	2	Sets the acceleration value
13	1	Get		Number of bytes
	1	Set	x	The deceleration value
	6	Get	1	Sets the deceleration value
14	1	Get		Number of bytes
	6	Set	2	The states and flags for mode 105
15	1	Get		Number of bytes
	1	Set	x	The filter index and value for debouncing
	6	Get	2	Sets filter index and value for debouncing

Modes and I/O

Refer to application notes manual F1-DVNETAN.

How to Control the F1-DVNET Module

The user MUST have a Master front-end application that is geared to send commands to this DeviceNet slave. Typical applications are usually found in embedded PLC's connected to the network, but advanced PC-based programs such as ThinkNDo Software allow easier user interaction with devices such as F1-DVNET.

How to Establish Connections

The user (Master) will attempt to select F1-DVNET and assume control by issuing an allocate command. This command informs the PLC that it is under the sole control of this device and that the PLC will ignore commands from all other devices during this period.

If data bytes are needed to complete the command they will be shown below the command line. Note that the MSB is shown last (rightmost position).

Msgid	Service	Class	Instance	Attribute	Macid
6	4B	3	1	3	xx

Note: Allocation 1 = explicit only
 3 = explicit and poll
 Macid The value of the Slave device

It is prudent to allocate both connections at once so that either route is available for immediate use.

How to Change the Baud Rate

Msgid	Service	Class	Instance	Attribute	Macid
4	10	3	1	2	xx
Data Byte 0					
2	500K baud				
1	250K baud				
0	125K baud				

Note: It is advisable to make baud rate changes to devices that are disconnected from the network. If you try to go on-line with devices with different baud rates you may experience communication difficulty. The mismatched baud rates can cause devices to temporarily fail and cause general network confusion. When all devices have the desired baud rates they may be connected to the network.

How To Change A Macid

Msgid	Service	Class	Instance	Attribute	Macid
4	10	3	1	1	xx

Note: Once the Macid is changed the unit will reset. The Master must accommodate for this new address.

How to Set the EPR

Msgid	Service	Class	Instance	Attribute	Macid
4	10	5	1	9	xx
Data Byte 0 and 1					
0	0	for no timeout			
10	0	for 10 millisecond timeout			
5	0	for 5 millisecond timeout			

Note: F1-DVNET has its main clock operating with an eight-millisecond resolution. That means the choice of an EPR value must be in increments of 8 milliseconds. F1-DVNET will adjust the desired EPR to the next multiple value. In the above example, the five-millisecond value would be changed to an eight-millisecond value.

Once a non-zero timeout value is set, the instance (1 for explicit, 2 for polling) the master MUST send a message at least once during that time span or the connection will break. When a connection breaks due to EPR timeout all outputs will go to zero as a precaution. A 0 value will allow the connection to remain open indefinitely and will not time out no matter how slow the traffic. The down side is that there will be no safeguard with regard to outputs should the connection be accidentally broken.

It is better to have the EPR setting at a comfortably large value so as to not burden the system with excessive or unnecessary traffic.

How To Send Parameters

Msgid	Service	Class	Instance	Attribute	Macid
6	10	15	1	1	xx

Please visit the Parameters Section and the Params section of the EDS description in appendix A.

How to Establish a Polling Connection

This is the most basic means of sampling input and driving the outputs. We cannot be certain of the exact command requirements of the Master to accomplish each of the commands found here, but the F1-DVNET will require the following steps in order to do I/O.

1. The Master needs to establish control over F1-DVNET...it must allocate the slave device.
2. Decide on the poll cycle and the EPR timeout. A non-zero EPR requires the Master to continuously send message traffic or the slave will timeout and drive all outputs zero. A zero EPR will prevent timeouts, but will eliminate the feature to automatically turn outputs off when communication ends.
3. Use parameter 2 to set F1-DVNET to Mode 60. This is the simplest mode and the one that allows all inputs and outputs without regard to any timing filters.
4. Execute the poll command

Glossary

Allocate	F1-DVNET is a server or slave to the master of the net. The master assumes control of each slave by sending the slave a special command that 'Allocates the Pre-defined Master Slave Connection Set'. When the slave accepts this command it is 'owned' by the master until the connection is broken.
Com1	RS-232 communications port. 9600 baud, 8 data bits, no parity, 1 stop bit
EMI	Electromagnetic Interference. As communications speeds increase, concern grows over noise and its potentially disruptive effects upon balanced twisted-pair telecommunications cabling. Electromagnetic compatibility (EMC) describes a cabling system's ability to minimize radiated energy levels (emissions) and resist noise interference from outside sources.
MACID	The DeviceNet network address. Each device on the network can have values from 0 to 63 and each must be unique.
Master	The device on the network that gathers and distributes I/O data for the process controller.
ODVA	Open DeviceNet Vendor Association. An organization devoted to supporting the Worldwide growth of DeviceNet and which manages the DeviceNet specification
Slaves	Devices from which the master gathers I/O data and to which the Master distributes I/O data. The slave NEEDS a Master, but only one is allowed to have control over the device. If another Master wants control of a slave, it must wait for the device to be unallocated.
UCMM	Unconnected Message Manager. This provides processing of unconnected requests and Responses. This is NOT implemented in F1-DVNET.

APPENDIX A: EDS File

An Electronic Data Sheet (EDS) provides configuration support in a special ASCII file. The information contained in this file provides the user with all the information needed to manage the device.

```
$ EDS for FACTS F1-DVNETS
```

```
[File]
```

```
DescText = "AUTOMATION Direct DL105 I/O Base Controller";
CreateDate = 02-21-2000;      $ created
CreateTime = 09:09:09;
Revision = 1.4;              $ revision of EDS
```

```
[Device]
```

```
VendCode = 660;
VendName = "AutomationDirect.com";
ProdType = 0;
ProdTypeStr = "Generic";
ProdCode = 10;
MajRev = 1;
MinRev = 2;
ProdName = "F1-DVNET";
Catalog = "F1-DVNET";
```

```
[IO_Info]
```

```
Default = 0x0001; $ Poll
PollInfo=
    0x0001,      $ Poll
    1,           $ Default input connection
    1;          $ Default Output connection

$ -- Input Connections --
Input1=
    2,           $ 10 bits in 2 bytes
    0,           $ all bits are significant
    0x0001,     $ Poll Connection
    "INPUT DATA", $ Name String
    6,           $ Path Size
    "20 04 24 01 30 03" $ class 4 inst1 attr 3
    "";

$ -- Output Connections --
Output1=
    1,           $ 8 bits
    0,           $ all bits are significant
    0x0001,     $ Poll Connection
    "OUTPUT DATA", $ Name String
    6,           $ Path Size
    "20 04 24 02 30 03" $ class 4 inst2 attr 3
    "";
```

```
[ParamClass]
```

```
MaxInst = 15;
Descriptor = 0; $ supports parameter instances
CfgAssembly = 0; $ configuration assembly not supported
```

```
[Params]
```

```
Param1 =
    0,           $ first field MUST be 0
    6,"20 15 24 01 30 01", $ link paths
    0,           $ descriptor setting...
    0xC7,       $ 16 bits unsigned
```

```

2,      $ number of bytes
"START RUN",
"Counter Ticks",
"Activates the process",      $ Starts the mode process (write)
0,      $ samples hsp counter (read)
0xFFFF,
0;

Param2 =
0,6,"20 15 24 02 30 01", 0, 0xC6,1,"105 MODE" ,"Usint" ,
"Current mode",0,0x60,0x60;
Param3 =
0,6,"20 15 24 03 30 01", 0, 0xC6,1,"ALLOW COUNTERS", "Usint",
"The number of presets",0,0x18,0;
Param4 =
0,6,"20 15 24 04 30 01", 0, 0xC6,1,"OUTPUT MASK", "Usint",
"Affected output bits master switch",0,0xFF,0;
Param5 =
0,6,"20 15 24 05 30 01", 0, 0xC6,1,"COUNTER VALUE", "Usint",
"Preset counter and value",0,0x18,0;
Param6 =
0,6,"20 15 24 06 30 01", 0, 0xC7,2,"OUTPUT BITS",
"index/value",
"Preset and outputs at counter value",0,0x18FFH,0;
Param7 =
0,6,"20 15 24 07 30 01", 0, 0xC6,1,"MODE 30 PROFILE", "Usint",
"Trap, Reg or Vel profile  ",0,0x3C,0;
Param8 =
0,6,"20 15 24 08 30 01", 0, 0xC7,2,"TARGET VELOCITY", "Hz",
"The max velocity  " , 0x40,0x4000,0x40;
Param9 =
0,6,"20 15 24 09 30 01", 0, 0xC8,4,"PRESET COUNTER", "Udint",
"32-bit preset counter value", 0,0x7FFFFFFF,0;
Param10 =
0,6,"20 15 24 0A 30 01", 0, 0xC8,4,"TARGET POSITION", "Udint",
"32-bit Target end point ",0,0xFFFFFFFF,0;
Param11 =
0,6,"20 15 24 0B 30 01", 0, 0xC7,2,"START VELOCITY", "Hz",
"Minimum motor velocity" ,0x40,0x4000,0x40;
Param12 =
0,6,"20 15 24 0C 30 01", 0, 0xC6,1,"ACCEL TIME SECS", "Usint",
"Seconds.tenths of accel time",0,0xF0,0;
Param13 =
0,6,"20 15 24 0D 30 01", 0, 0xC6,1,"DECEL TIME SECS", "Usint",
"Seconds.tenths of decel time",0,0xF0,0;
Param14 =
0,6,"20 15 24 0E 30 01", 10, 0xC6,1,"FLAGS & STATES", "Usint",
"Internal operational characteristics", 0, 0xFF,0;
Param15 =
0,6,"20 15 24 0F 30 01", 0, 0xC7,2,"FILTER TIME",
"index/value",
"Index/Filter time in # 8mls", 0, 0x480,0;

$ END EDS for FACTS F1-DVNETS

```

APPENDIX B: PC Loader Program

F1-DVNET Loader

F1-DVNET is a FLASH memory product. This type of memory is called in-system Programmable and Erasable Read Only Memory (PEROM). The logic is easily changed in the field by using a PC-based loader program described here. System memory will normally remain solid, but when program updates occur or additional features are added to the system, the user will be able to modify the program. Also refer to F1-DVNETAN for special needs programming.

Communication between the F1-DVNET OS Loader and the F1-DVNET module occurs over the COM1 line running at 9600 baud. This speed is adequate to handle the download functions and to allow some utility functions that can read and display data within the module. Selectable higher baud rates may be available in later revisions of the product.

Loader Basics

NOTE: Before making the serial connection, make sure the PC is ground isolated or disconnect the DeviceNet cable from the F1-DVNET module. This node contains an isolated physical layer and components referenced to V- will connect to the external device over the serial port cable. The goal is to help prevent damage to the unit that may result when an unintentional power source is applied to the system.

The F1-DVNET power-up sequence sends out a specific message that alerts the PC Loader to commence a dialog with F1-DVNET. The "I-am-here" message:

```
F1-DVNET MACID=xx CAN Baud Rate=ABCK Vx.x T-5D ROM mm/dd/yyyy FLASH mm/dd/yyyy
```

has a fixed string plus additional data for the PC Loader to identify the module, the devicenet communications rate, the type of FLASH and the date of the firmware. F1-DVNET waits briefly (1-2 seconds) while it monitors the communication port. If no valid PC-Loader protocol information occurs during that period F1-DVNET advances to its normal processing logic that responds to DeviceNet commands. If loader commands are recognized F1-DVNET will only process commands from the com1 port and will remain in this mode until power down occurs or if the loader issues a 'run' command. During this com1 protocol exchange, the red module LED will be on when F1-DVNET sends data to the PC.

If the identifying message has "???" for data then the memory has been corrupted, erased or simply not loaded. If the message is garbled there may be a baud rate problem. Power down F1-DVNET, place the jumper on the J1 pins and power up again. After a few seconds power-down, remove the jumper and power-up with the system connected to HyperTerminal running on the PC. The identifying message should appear this time with a macid of 3F and a 125K baud rate value.

The PC Loader enables the user to download programs or to examine the memory in order to help diagnose problems. The PC-loader and F1-DVNET use timeout functions to prevent indefinite waiting. The user must be aware of the necessity of running the PC Loader and F1-DVNET in a way that allows a quick establishment of a communications link between them. F1-DVNET has a very short timeout compared to the PC Loader so it should be started LAST.

When the F1-DVNET Loader recognizes the F1-DVNET, a dialog begins that causes the F1-DVNET to remain under control of local routines instead of advancing to the generic DeviceNet processing logic. Once in these special routines the only way out is to toggle power.

Download Programs

Start the PC Loader first (See figure B1). This program will work with any hex file that has an Intel format. Just be sure the program is compatible with the DS87C520.

WARNING: Loading incompatible programs will produce indeterminate results and could result in damage or injury.

Follow the steps. Select the desired program by toggling the Directory/filename window. This choice can be made anytime prior to the actual download.

First, select the proper port and select 'Next'. See B2 for the displayed window. Connect the proper cable between the PC and F1-Dvnet and select 'Next'. See B3 for the displayed window. The FetchFlash option is now available (Examine Memory) or press 'Next' to activate a warning message (see figure B4) indicating the FLASH is about to change. Select 'No' to abort the download or 'Yes' to activate the download trigger. See B5 for the displayed window. The PC is waiting for the indication from the F1-DVNET to proceed with the load. Simply cycle the F1-Dvnet power off-on to start the download.

Figure B6 shows the status window as the program is being loaded into the F1-DVNET memory. The numbers refer to the approximate percentage of the download that is complete. Figure B7 will result when the entire program has been transferred.

Examine memory

Start the PC Loader first. The goal is to have the PC program waiting on the F1-DVNET so depress 'Next' until the FetchFlash menu item is active. Ignore the program load window.

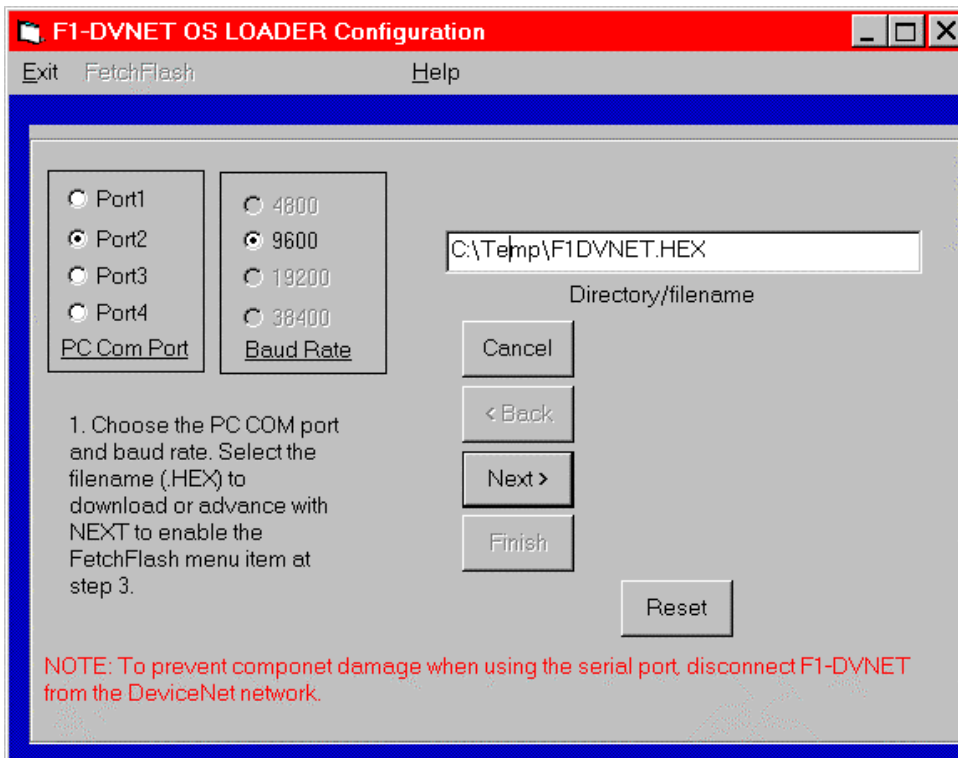

Figure B1 Loader Program Initial Screen

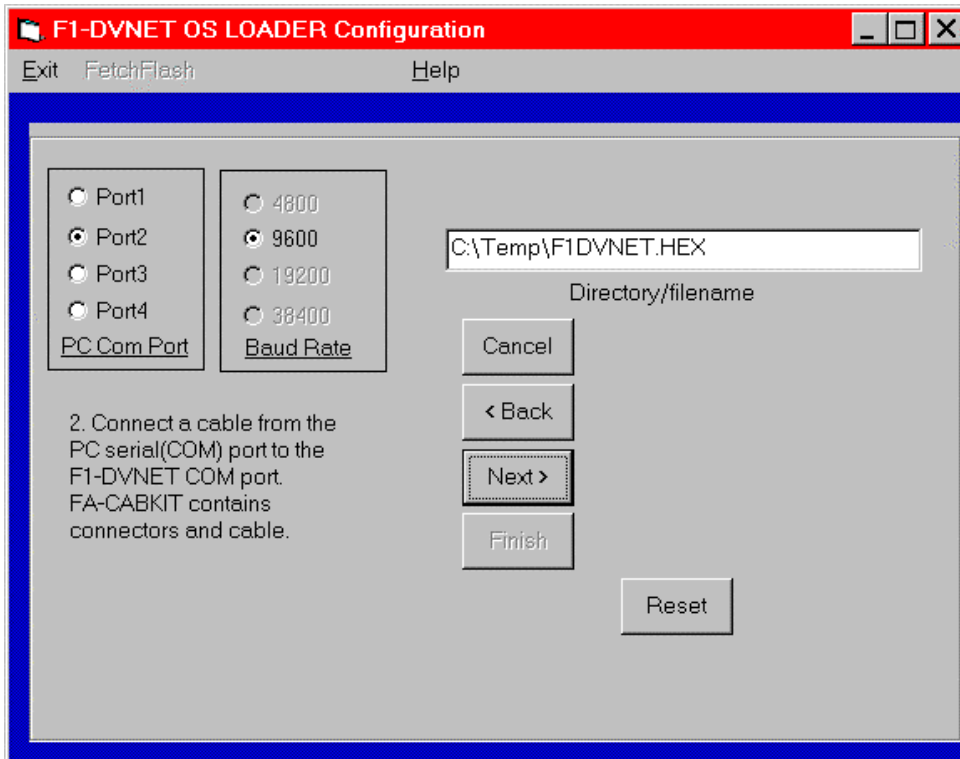

Figure B2 Loader Program Successive Window

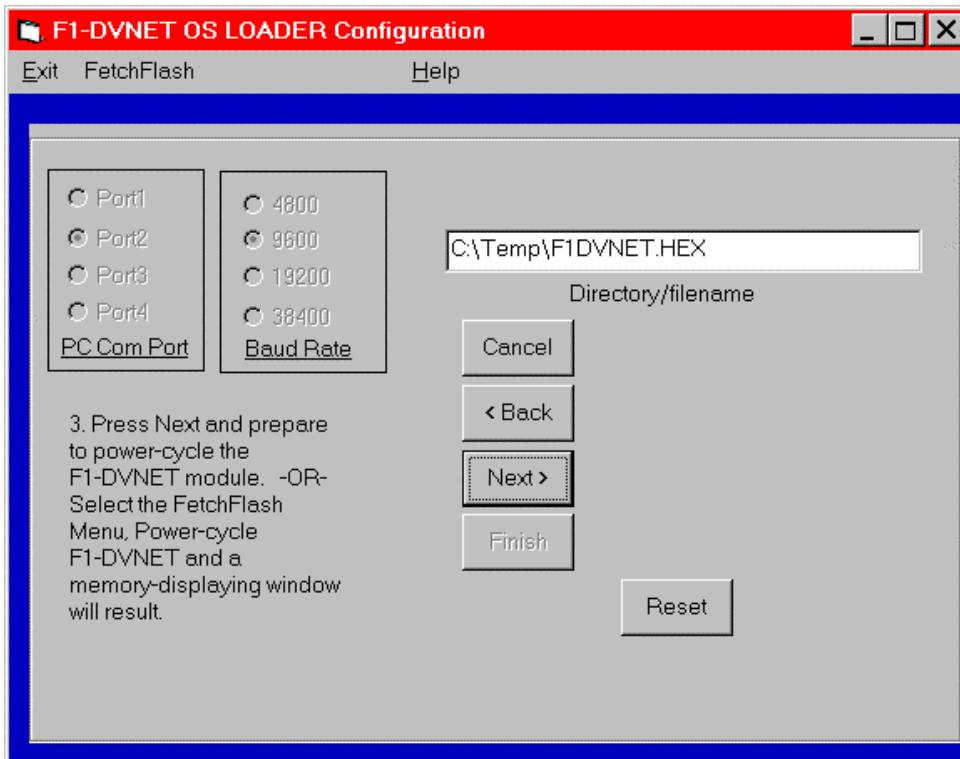

Figure B3 Loader Program Screen Showing Step 3 of the Download Process

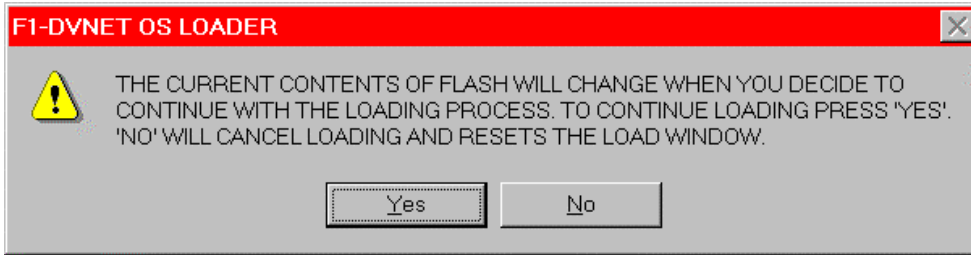

Figure B4 A warning message alerting the user the flash contents will change

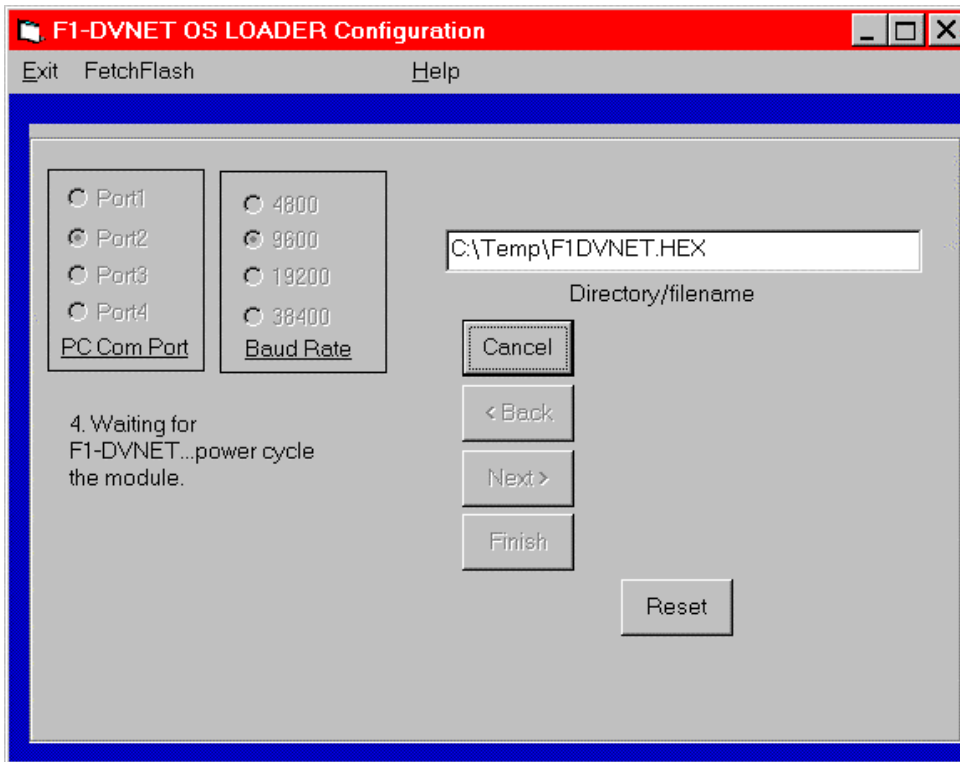

Figure B5 Loader Program Screen Showing Step 4 of the Download Process

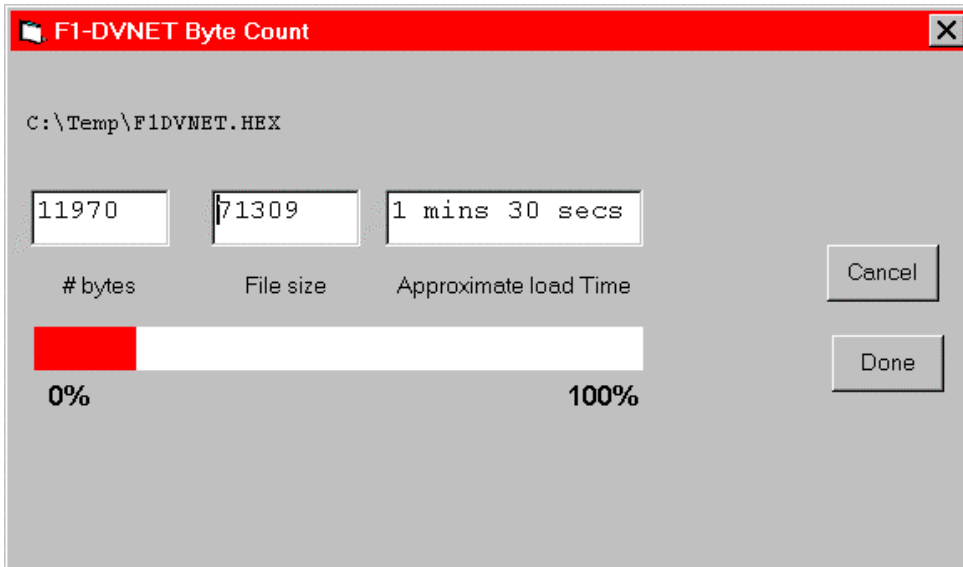

Figure B6 Loader Program Window showing the Progress of a Download

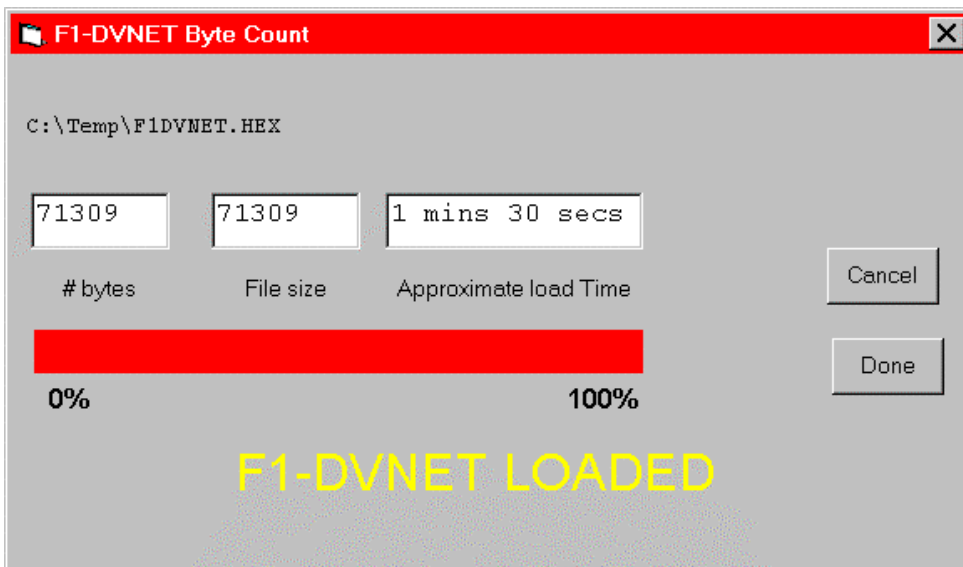

Figure B7 Load Complete Window

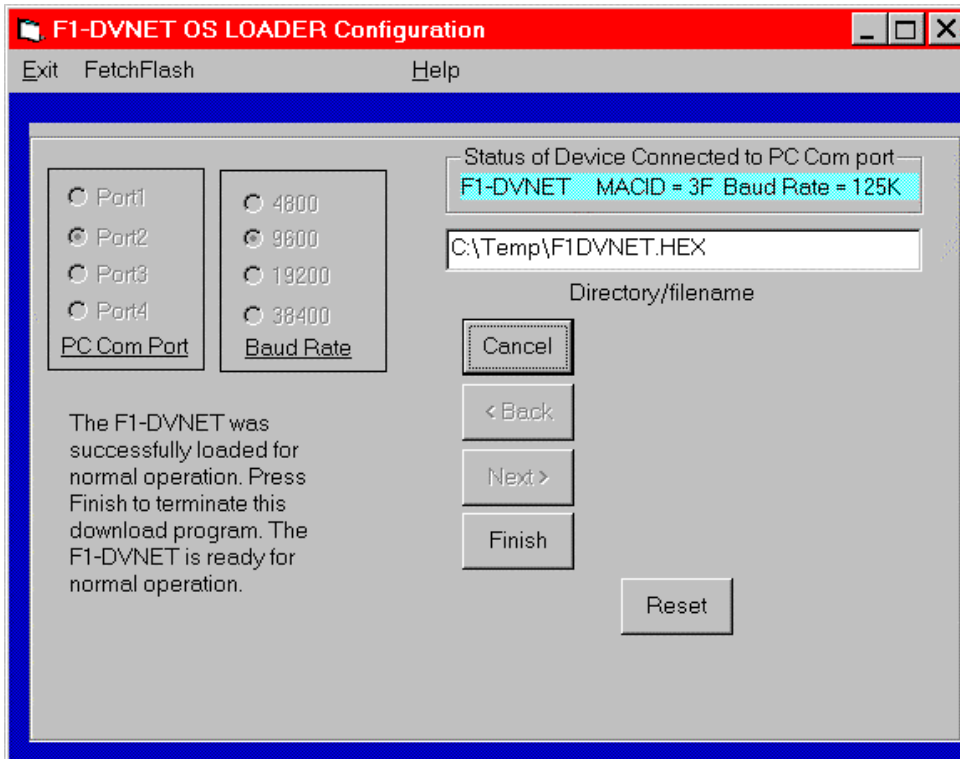

Figure B8 Loader Program End Window

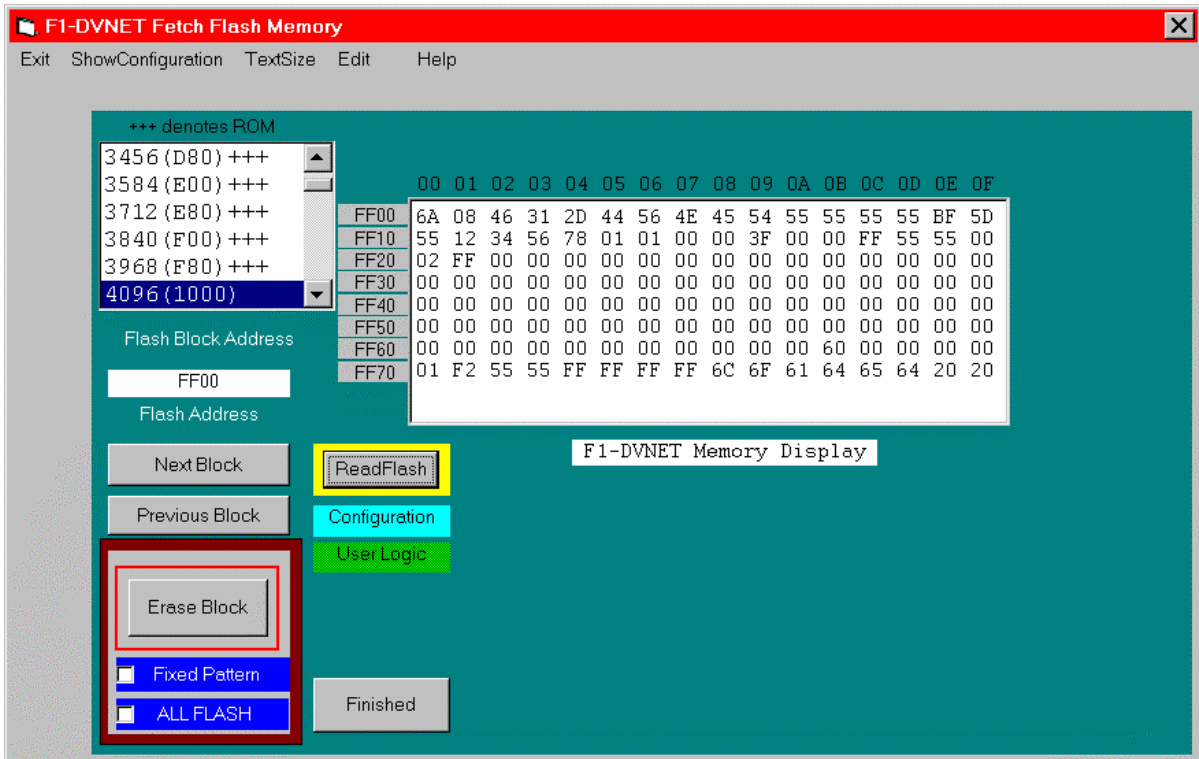

Figure B9 Loader Program Display resource Window

Flash Block Address	The memory is available as 128-byte blocks of data. The user can select the desired memory block by double-clicking the address in the Flash Block Address window.
Flash Address	This is the address in F1-DevNet of the data being displayed
Next Block	Selects the next available block address and displays the data
Previous Block	Selects the previous block address and displays the data
Erase Block	Resets all bytes to FF in the block...there is NO UNDO
Fixed Pattern	Sets a fixed value of 22 to each byte value in the block...there is NO UNDO
All Flash	Selects all flash memory to erase. This is password protected. It sets all but the last two blocks of flash to FF. This is the configuration area
Read Flash	Samples the data again
Configuration	Chooses the special configuration data block at FF00
User Logic	Refer to F1-DVNET-AN, the F1-DVNET Application Notes Manual.
Finished or Exit	Done with this window
Show Configuration	See B10 (next page)
Display window	Shows the 128-bytes of memory in hex

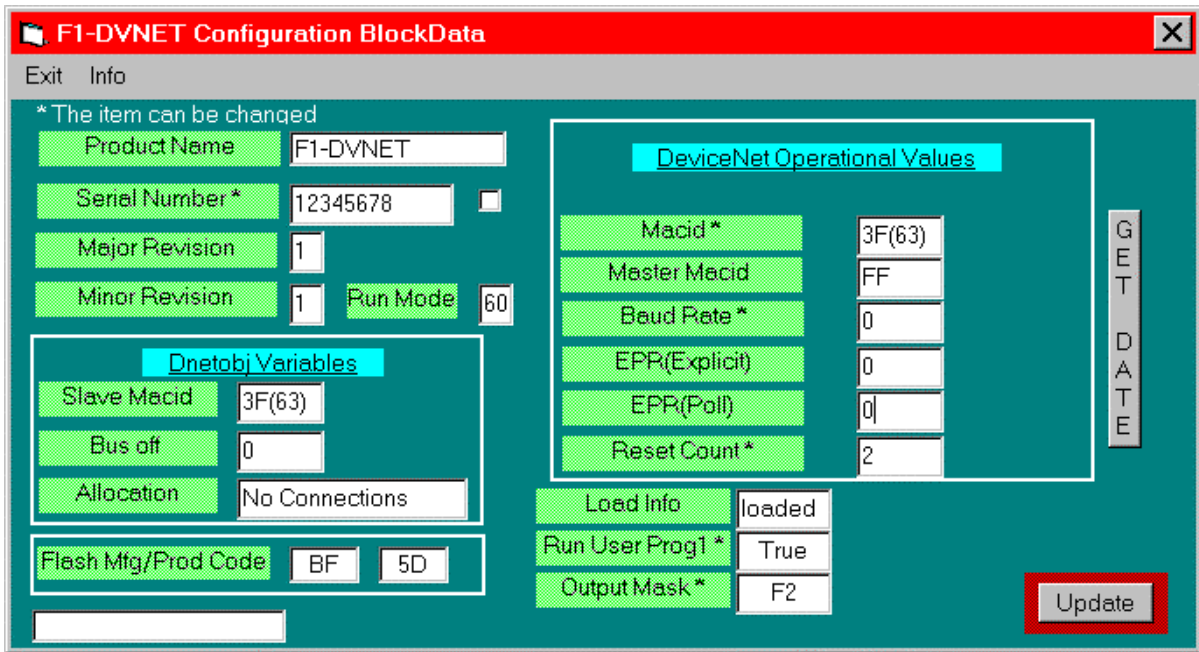

Figure B10 Loader Program Update Resource Window

- | | |
|------------------|--|
| Product Name | - Product name |
| Serial Number | - Can be changed, but requires a password |
| Major/Minor | - Shows the software Version (Major) and revision (Minor) values |
| Run Mode | - Processing mode |
| Slave Macid | - Local numbering |
| Bus Off | - Bus off error count |
| Allocation | - Last known connection value |
| Mfg/Prod code | - Identifies the type of flash |
| Macid | - Local address (Slave Macid). This is changeable. |
| Baud Rate | - 0,1,2 indicate network speeds of 125k, 250k and 500K respectively. This is changeable. |
| EPR (Explicit) | - Expected packet rate for explicit messaging |
| EPR (Poll) | - Expected packet rate for polling |
| Reset Count | - The number of timer the unit has been reset...powered-down then up |
| Loaded | - Indicated the status of the last download |
| Run User program | - Refer to F1-DVNET-AN, the F1-DVNET Application Notes Manual. |
| Output Mask | - Refer to F1-DVNET-AN, the F1-DVNET Application Notes Manual. |
| Update | - Permanently writes the changed fields to memory. |
| Get Date | - Displays the creation dates of the ROM and FLASH portions of memory. |